

Cadet 260 S Gris clair 2005 - Z11113

Cadet 260 LR Gris clair 2005 - Z11115

N° 3452114B SAV

DJA - 05.2005

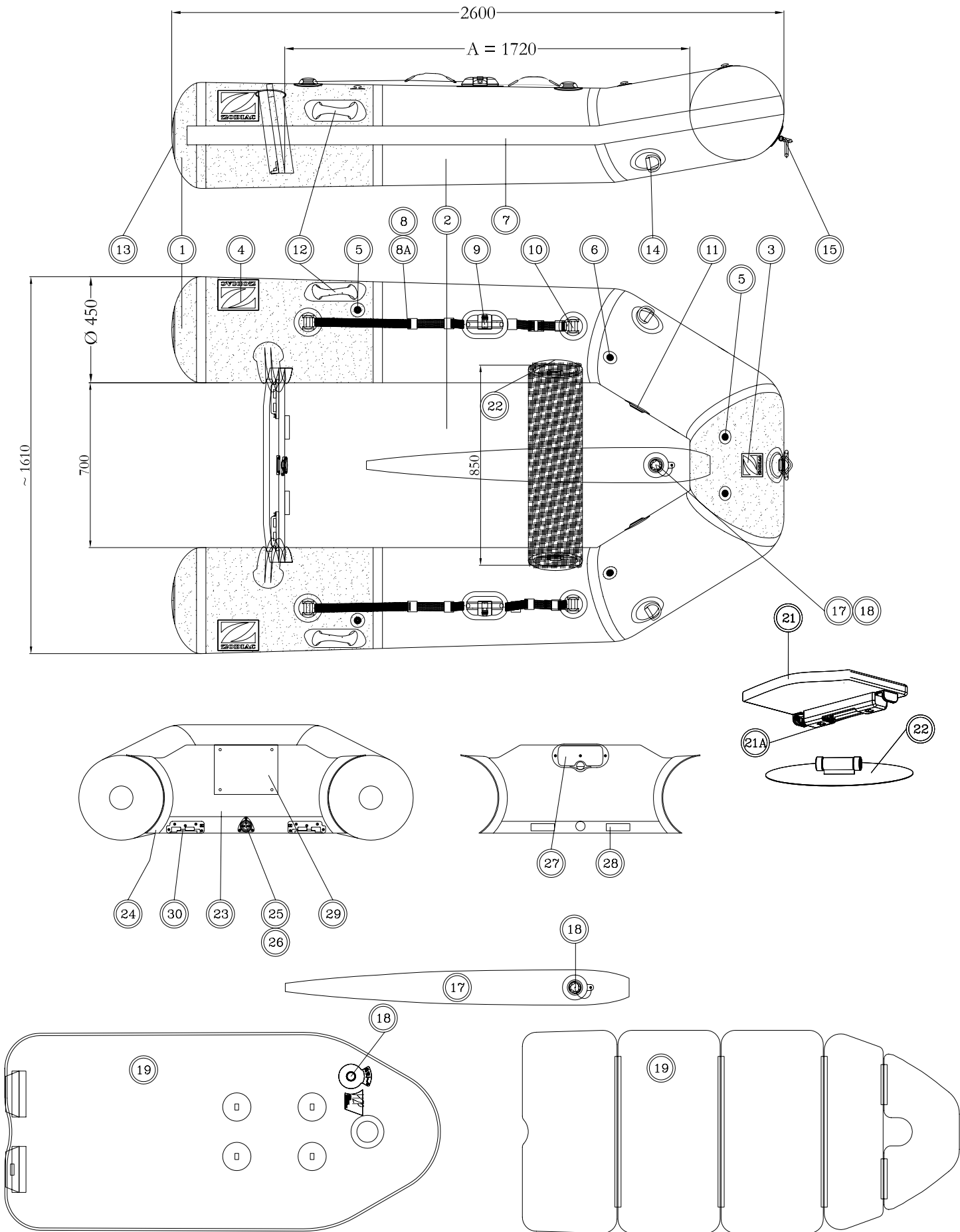

PIECES CADET S / LR GRIS SPARE PARTS GREY CADET S / LR

GDB/9.05

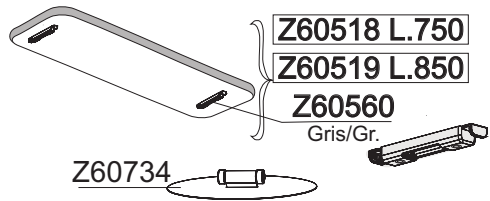
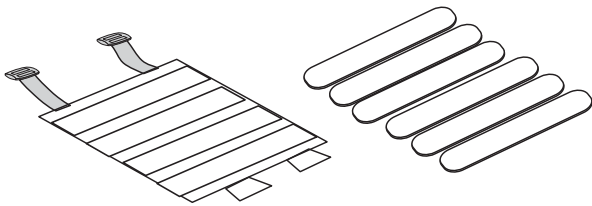
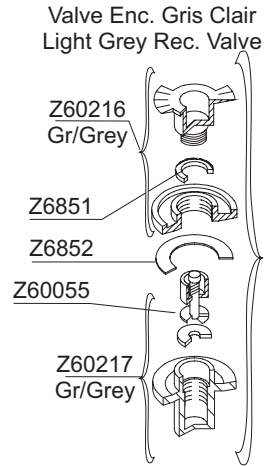
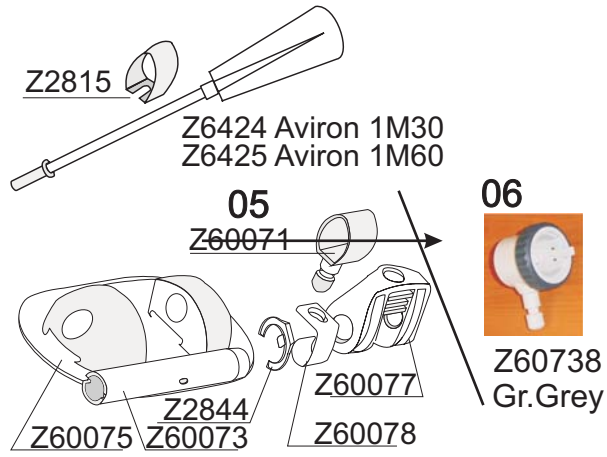

Support tissu Gris/Grey.fab.Support

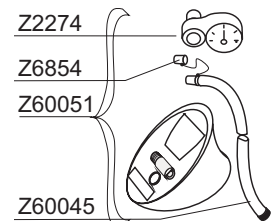
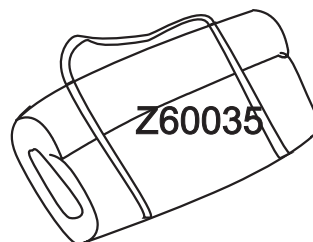
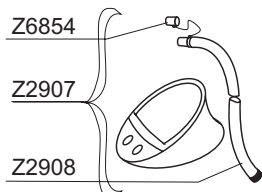
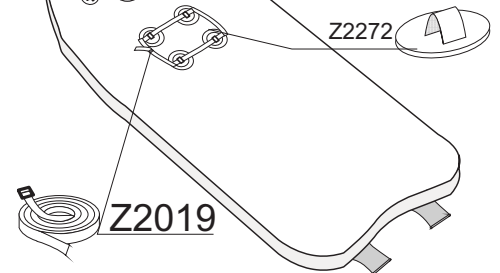
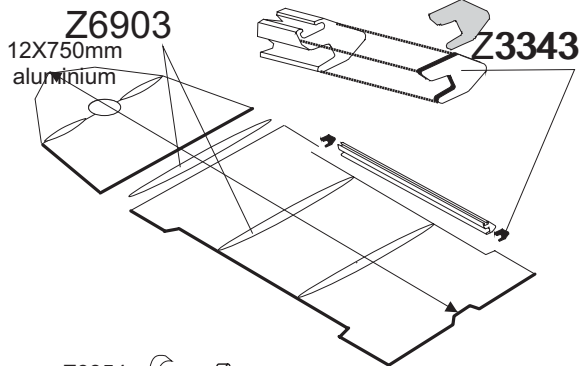
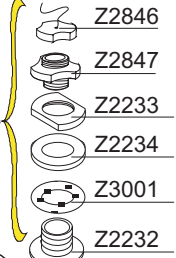
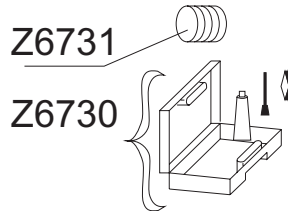
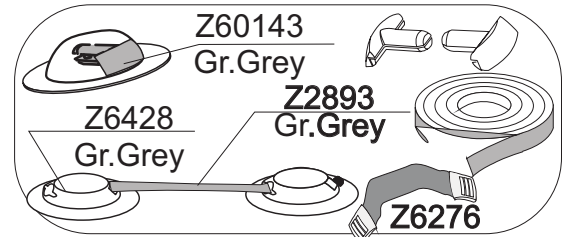
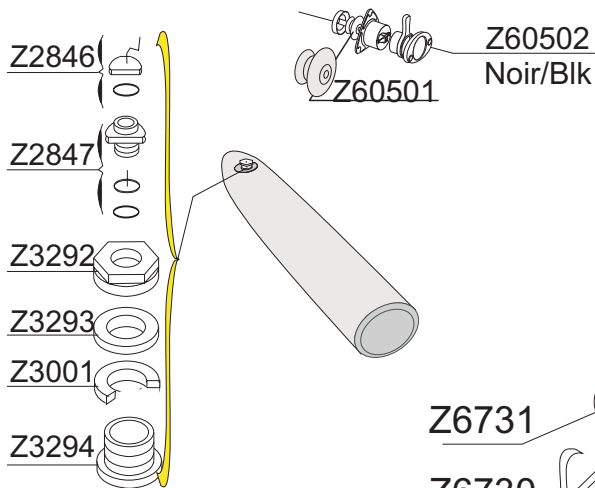

Z11113 CADET 260 S GRIS CLAIR 2005				10 08 2005
Rep.	Qty	PTN°	Description FR	Description GB
EQUIPMENT FLOTTEUR -- BUOYANCY TUBE EQUIPMENT				
1	M	Z7186	T/STG BLEU MARINE	NAVY BLUE FABRIC
2	M	Z7041	T/REPAR.950 GRIS CLAIR	LIGHT GREY REPAIR FABRIC
3	1	Z60018	LOGO "Z" 02 PM BLEU JAUNE (1)	LOGO "Z" 02 SMALL BLUE YEL(1)
4	2	Z60019	LOGO "Z" 02 GM BLEU JAUNE (1)	LOGO "Z" 02 LARGE BLUE YELL(1)
5	2	Z3957	PLOT FIX.SAC/AVIR NO (10)	PLAST.ATTACH.OAR/BAG10BLK
6	4	Z2816	PLOT FIX.SAC/AVIR.GRIS (4)	PLAST.ATTACH.OAR/BAG GR4
7	1	Z60606	DEFENSE GR.M/BLEU/JAU 8M10	RUB STRAKE M.GR./BLU/YEL.8M10
8	4	Z6276	PG SURMOULEE GRISE SNG 35 (2)	HANDLE F/SAFETY STRAP GREY (2)
8A	M	Z2893	SANGLE GRISE L35MM (10M)	GREY STRAP 35MM (10M)
9	2	Z60738	TOLET BLOQUEUR AVIRON GRIS (2)	OAR LOCK JUBILEE CLIP GREY (2)
9	2	Z60073	AXE DN BASC. 01 GR-CL (1)	AXE RECL.OAR 01 GREY (1)
9	2	Z2844	AN.AXE DAME BASCUL.GR(10)	RING F/RECL.OAR GR 10
9	2	Z60075	EMBASE 01 DN BASC. GR-CL (1)	SUPPORT RECLINING OAR 01 GREY
9	2	Z60077	COQUILLE. 02 GR-CL DNB. (1)	SWIVEL RECLINING OAR 02 GREY
9	2	Z60078	BOUTON RESSORT DAME NAGE(2)	RETAINER FOR OAR SWIVEL 02 (2)
10	4	Z6428	PAS.SANGL/DRISS.GR/CL.(1)	MOULD.STRAP/ROPE HOLD 1GR
10	4	Z60143	VERROU SANGLE "T" GR. (4)	RETAINER FOR STRAP "T" GR (4)
11	2	Z60216	BOUCHON VIS VALVE ENC GR CL(5)	CAP THREAD RECES.VALVE(5)GREY
11	2	Z6851	JT BOUCHON V.E. (25)	GASKET/CAP RECESSED VALVE (25)
11	2	Z6852	JT ECROU V.E.(10)	GASKET/SCREW RECES.VALVE (10)
11	2	Z60055	SUPPORT CLAP. VALVE ENC.02(10)	RECESSED VALVE INSERT 2002(10)
11	2	Z60217	CORPS VALVE ENCASTREE GR CL(5)	BODY/SCREW.RECES.VALVE GR(5)
12	1	Z3077	PG LAT GAUCHE GRIS/CL 95	GREY CARR HD LEFT 95
12	1	Z3078	PG LAT DROITE GRIS/CL 95	GREY CARR HD RIGHT 95
13	2	Z60607	CONE 05 CALOTTE NOIRE D201	CONE END 05-D201 BLACK FABRIC
14	2	Z2303	AD 53 ROND GRIS CLAIR (2)	D RING 53 ROUND L.GREY(2)
15	1	Z60093	PG AV RONDE GRI-CL 03	GB BOW HANDLE LIGHT GREY ROUND 03
QUILLE & VALVE -- INFLATABLE KEEL				
17	1	Z60580	QUILLE CADET 260 05	KEEL CADET 260 05
18	1	Z2846	BOUCHON CLAPET DELRIN(10)	CAP BLACK VALVE (P10)
18	1	Z2847	CORPS CLAPET DELRIN(10)	DELRIN BLACK VALVE (P10)
18	1	Z3292	ECROU EMB DELRIN(10)	DELRIN COLLAR NUT (10)
18	1	Z3293	ROND EMB DELRIN(10)	GASKET INSERT DELRIN BASE
18	1	Z3001	JT NEO.EMBASE CLAPET(25)	GASKET INSERT BASE NEOPRE (25)
18	1	Z3294	EMB F.CARRE DELRIN(10)	DELRN VALV INSRT BASE(10)
PLANCHER -- WOODEN FLOOR				
19	1	Z60584	PLANCHER C 260S EVOL TRONQ 05	WOOD FLOOR C 260S 05 MODEL
20.05.05			KIT PLANCHER 06+2LONG.Long.900 -- WOOD.FLOOR SET 06	
		Z60726	PLANCHER 3+4+5 C260 - KIT06	FLOOR BD.PT.3+4+5 C260-06 SET
		Z6452	LONGERON A RAIL 12X900	STRINGER W RAIL 12X900
BANC -- WOODEN BENCH				
21	1	Z60518	BANC QUICK FIT 750 GR.CL 05	QUICK FIT BENCH L750 L GREY
21A	2	Z60560	SUPPORT MULTIF.GRIS BANC 05(2)	QUICK FIT BENCH RETAINER GR 05
22	2	Z60734	SUPP BANC RENFORCE T/GR.CL (2)	SUPP/GR.FAB.V2 QCK FIT BENCH
TABLEAU -- TRANSOM				
23	1	Z60578	TABLEAU T3 BLEU NUIT	TRANSOM T3 DARK BLUE
24	2	Z2250	GLISSIERE TABLEAU NOIR (1)	TRANSOM BRACKET MKI/IGT
25	1	Z60502	VIDE VITE A LEVIER NOIR (1)	SELF BAILER/LEVER TYPE BLACK(1)
26	1	Z60501	MEMBRANE VIDE VITE LEVIER (5)	DIAPHRAGM /02 SELF BAILER (5)
27	1	Z6087	PLAQUE MOTEUR PM 99	MOTOR MOUNTING PLATE S2
28	2	Z3143	TASSEAU MULTIF GR-CL (10)	PLAST.FLOOR RETAINER GR10
29	1	Z2042	PLAQUE MARTYRE VERNIE 12MM	WOODEN TRANSOM PAD12MM WARNISH
30	1	Z60710	PRE EQUIPMENT FLAP NOIR	PRE-EQUIPMENT FLAP BLK 05 SET
EQUIPMENT STANDARD STANDART EQUIPMENT				
	2	Z6425	AVIRON GRIS 1.60XD35 (2)	GREY OAR 1,60XD35 (2)
	2	Z2815	CLIP AVIRON GRIS CLAIR(2)	OAR CLIP -GREY PLASTIC- (2)
	1	Z2907	GONFLEUR BV1 TUYAU JAUNE	PUMP WITH YELLOW HOSE BV1
	1	Z2908	TUYAU SOUF.JAUN 3891/2907	HOSE F/ PUMP--3891/2907
	1	Z6854	RACCORD VALVE ENCAST TUY/GONFL	COUPLING RECESSED VALVE
	1	Z60035	SAC ZODIAC ANNEXE GM 2002	CARRY BAG ZODIAC TENDER LARGE
	1	Z6730	V/REP.BATEAUX STRONGAN	STRONGAN BOATS REPAIR KIT
	1	Z6731	PALETTE PIECES TISSU /REPAR.ST	FAB.PATCHES STG FOR REPAIR
	1	Z60186	AUTO-COLLANT SECURITE	STICKER -SAFETY-
	1	Z3018	MAN.PROP T1 GENERALITES	MAN.PROP T1 GENERALITES
	1	Z7136	MAN.PROP T2 CADET-CADET S	OWN.MAN.VOL2 CADET-CADETS

Z11115 CADET 260 LR GRIS CLAIR 2005				10 08 2005
Rep.	Qty	PTN°	Description FR	Description GB
EQUIPMENT FLOTTEUR -- BUOYANCY TUBE EQUIPMENT				
1	M	Z7186	T/STG BLEU MARINE	NAVY BLUE FABRIC
2	M	Z7041	T/REPAR.950 GRIS CLAIR	LIGHT GREY REPAIR FABRIC
3	1	Z60018	LOGO "Z" 02 PM BLEU JAUNE (1)	LOGO "Z" 02 SMALL BLUE YEL(1)
4	2	Z60019	LOGO "Z" 02 GM BLEU JAUNE (1)	LOGO "Z" 02 LARGE BLUE YELL(1)
5	2	Z3957	PLOT FIX.SAC/AVIR NO (10)	PLAST.ATTACH.OAR/BAG10BLK
6	4	Z2816	PLOT FIX.SAC/AVIR.GRIS (4)	PLAST.ATTACH.OAR/BAG GR4
7	1	Z60606	DEFENSE GR.M/BLEU/JAU 8M10	RUB STRAKE M.GR./BLU/YEL.8M10
8	4	Z6276	PG SURMOULEE GRISE SNG 35 (2)	HANDLE F/SAFETY STRAP GREY (2)
8A	M	Z2893	SANGLE GRISE L35MM (10M)	GREY STRAP 35MM (10M)
9	2	Z60738	TOLET BLOQUEUR AVIRON GRIS (2)	OAR LOCK JUBILEE CLIP GREY (2)
9	2	Z60073	AXE DN BASC. 01 GR-CL (1)	AXE RECL.OAR 01 GREY (1)
9	2	Z2844	AN.AXE DAME BASCUL.GR(10)	RING F/RECL.OAR GR 10
9	2	Z60075	EMBASE 01 DN BASC. GR-CL (1)	SUPPORT RECLINING OAR 01 GREY
9	2	Z60077	COQUILLE. 02 GR-CL DNB. (1)	SWIVEL RECLINING OAR 02 GREY
9	2	Z60078	BOUTON RESSORT DAME NAGE(2)	RETAINER FOR OAR SWIVEL 02 (2)
10	4	Z6428	PAS.SANGL/DRISS.GR/CL.(1)	MOULD.STRAP/ROPE HOLD 1GR
10	4	Z60143	VERROU SANGLE "T" GR. (4)	RETAINER FOR STRAP "T" GR (4)
11	2	Z60216	BOUCHON VIS VALVE ENC GR CL(5)	CAP THREAD RECES.VALVE(5)GREY
11	2	Z6851	JT BOUCHON V.E. (25)	GASKET/CAP RECESSED VALVE (25)
11	2	Z6852	JT ECROU V.E.(10)	GASKET/SCREW RECES.VALVE (10)
11	2	Z60055	SUPPORT CLAP. VALVE ENC.02(10)	RECESSED VALVE INSERT 2002(10)
11	2	Z60217	CORPS VALVE ENCASTREE GR CL(5)	BODY/SCREW.RECES.VALVE GR(5)
12	1	Z3077	PG LAT GAUCHE GRIS/CL 95	GREY CARR HD LEFT 95
12	1	Z3078	PG LAT DROITE GRIS/CL 95	GREY CARR HD RIGHT 95
13	2	Z60607	CONE 05 CALOTTE NOIRE D201	CONE END 05-D201 BLACK FABRIC
14	2	Z2303	AD 53 ROND GRIS CLAIR (2)	D RING 53 ROUND L.GREY(2)
15	1	Z60093	PG AV RONDE GRI-CL 03	GB BOW HANDLE LIGHT GREY ROUND 03
QUILLE & VALVE -- INFLATABLE KEEL				
17	1	Z60580	QUILLE CADET 260 05	KEEL CADET 260 05
18	1	Z2846	BOUCHON CLAPET DELRIN(10)	CAP BLACK VALVE (P10)
18	1	Z2847	CORPS CLAPET DELRIN(10)	DELRIN BLACK VALVE (P10)
18	1	Z3292	ECROU EMB DELRIN(10)	DELRIN COLLAR NUT (10)
18	1	Z3293	ROND EMB DELRIN(10)	GASKET INSERT DELRIN BASE
18	1	Z3001	JT NEO.EMBASE CLAPET(25)	GASKET INSERT BASE NEOPRE (25)
18	1	Z3294	EMB F.CARRE DELRIN(10)	DELRN VALV INSRT BASE(10)
PLANCHER H2P -- H2P FLOOR				
19	1	Z60634	PLANCHER H2P C260 BASIC LR 05	AIR FLOOR H2P CADET 260 LR 05
20	1	Z2846	BOUCHON CLAPET DELRIN(10)	CAP BLACK VALVE (P10)
20	1	Z2847	CORPS CLAPET DELRIN(10)	DELRIN BLACK VALVE (P10)
20	1	Z2233	ECROU EMBASE (10)	NUT VALVE INSERT BASE (P10)
20	1	Z2234	RONDELLE EMBASE (10)	GASKET VALVE INSERT BASE (P10)
20	1	Z3001	JT NEO.EMBASE CLAPET(25)	GASKET INSERT BASE NEOPRE (25)
20	1	Z2232	EMBASE CLAPET (10)	VALVE INSERT BASE (P10)
BANC -- WOODEN BENCH				
21	1	Z60518	BANC QUICK FIT 750 GR.CL 05	QUICK FIT BENCH L750 L GREY
21A	2	Z60560	SUPPORT MULTIF.GRIS BANC 05(2)	QUICK FIT BENCH RETAINER GR 05
22	2	Z60734	SUPP BANC RENFORCE T/GR.CL (2)	SUPP/GR.FAB.V2 QCK FIT BENCH
TABLEAU -- TRANSOM				
23	1	Z60578	TABLEAU T3 BLEU NUIT	TRANSOM T3 DARK BLUE
24	2	Z2250	GLISSIERE TABLEAU NOIR (1)	TRANSOM BRACKET MKI/IGT
25	1	Z60502	VIDE VITE A LEVIER NOIR (1)	SELF BAILER/LEVER TYPE BLACK(1)
26	1	Z60501	MEMBRANE VIDE VITE LEVIER (5)	DIAPHRAGM /02 SELF BAILER (5)
27	1	Z6087	PLAQUE MOTEUR PM 99	MOTOR MOUNTING PLATE S2
28	2	Z3143	TASSEAU MULTIF GR-CL (10)	PLAST.FLOOR RETAINER GR10
29	1	Z2042	PLAQUE MARTYRE VERNIE 12MM	WOODEN TRANSOM PAD12MM WARNISH
30	1	Z60710	PRE EQUIPMENT FLAP NOIR	PRE-EQUIPMENT FLAP BLK 05 SET
EQUIPMENT STANDARD STANDART EQUIPMENT				
	2	Z6424	AVIRON GRIS 1.60XD35 (2)	GREY OAR 1,60XD35 (2)
	2	Z2815	CLIP AVIRON GRIS CLAIR(2)	OAR CLIP -GREY PLASTIC- (2)
	1	Z60051	GONFLEUR BRAVO 5 HP + MANO	HIGH PRESS. BRAVO 5 + P GAUGE
	1	Z60045	TUYAU GONFLEUR H2P ANNEXE	HOSE F/TENDER H2P FOOT PUMP
	1	Z6854	RACCORD VALVE ENCAST TUY/GONFL	COUPLING RECESSED VALVE
	1	Z60035	SAC ZODIAC ANNEXE GM 2002	CARRY BAG ZODIAC TENDER LARGE
	1	Z6730	V/REP.BATEAUX STRONGAN	STRONGAN BOATS REPAIR KIT
	1	Z6731	PALETTE PIECES TISSU /REPAR.ST	FAB.PATCHES STG FOR REPAIR
	1	Z2019	SANGLE RESERVOIR	TIE DOWN STRAP F/AIRFLOOR
	1	Z3018	MAN.PROP T1 GENERALITES	MAN.PROP T1 GENERALITES
	1	Z60360	MAN PROP. T2 CADET FR.ACTI-V	OWNERS MAN V.2 CADET FR ACTI-V